

# ProShot™ Cordless Paint Sprayer

U.S. Patent No. D625,775 S; U.S. Patent No. 6,619,569; U.S. Patent No. D630,708 S;  
Community Registration #001228255; India Patent No. 230058; Taiwan Patent No. D142952  
China Patent No. ZL201030238948.3; and other patents pending

3A0153E  
EN

**- For portable spray applications of water-based and oil-based  
(mineral spirit-type) architectural paints and coatings only -  
- Not for use in explosive atmospheres -**



### IMPORTANT SAFETY INSTRUCTIONS

Read all warnings and instructions in this manual. Save these instructions.



### Model 258865

Maximum Working Pressure 2000 psi (137 bar, 13.7 MPa)



### Model 258859

Maximum Working Pressure 2000 psi (137 bar, 13.7 MPa)

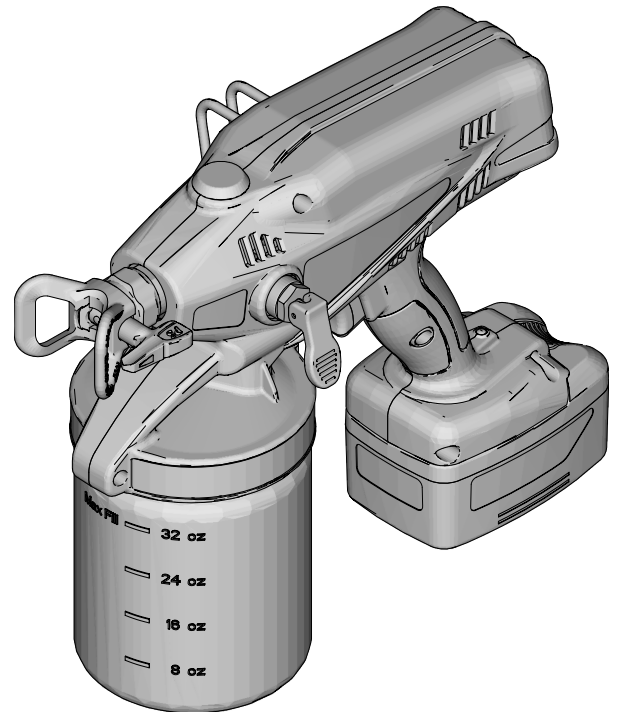

## ⚠ WARNING



**Use only water-based or oil-based (mineral spirit-type) materials with flash point greater than 100° F (38° C).** Do not use materials which state "FLAMMABLE" on the packaging. For more information about your material, request MSDS from distributor or retailer.

Use oil-based material outdoors or in a well-ventilated indoor area with a flow of fresh air.

**Spraying certain materials may cause static build-up in the sprayer that can result in static shock to the user.** If this occurs, first ensure the material has a flash point greater than 100° F (38° C) and does not state that it is FLAMMABLE anywhere on the package. If still feeling a static shock, the material likely contains a non-mineral spirits fluid such as, but not limited to, xylene, toluene, or naphtha, which can build up static. Switch to an alternative material.

# Table of Contents

<b>Warnings</b> .....	<b>3</b>	<b>Getting Started with Basic Techniques</b> .....	<b>11</b>
<b>Component Identification</b> .....	<b>5</b>	Triggering Sprayer .....	11
<b>Common Procedures</b> .....	<b>6</b>	Aiming Sprayer .....	11
Pressure Relief Procedure .....	6	<b>Unclogging Spray Tip/Guard Assembly</b> .....	<b>12</b>
Trigger Lock .....	6	<b>Shutdown and Cleaning</b> .....	<b>13</b>
Spray Tip Position .....	6	Flushing Sprayer .....	13
Prime/Relief Valve Position .....	6	Cleaning Sprayer Exterior .....	15
<b>Charging the Battery</b> .....	<b>7</b>	Tips .....	15
Charger Status Indicator Lights .....	7	<b>Storage</b> .....	<b>15</b>
Sprayer Status Indicator .....	7	<b>Replacement Parts and Kits</b> .....	<b>16</b>
<b>Setup</b> .....	<b>8</b>	<b>ProShot Repair Kit</b> .....	<b>17</b>
Suction Tube Selection .....	8	Outlet Valve Fitting .....	17
Spraying Stains or Clear Coats (Fine-Finish Optimizer) .....	9	<b>Alternate Priming Method</b> .....	<b>18</b>
Sprayer Setup .....	9	Inlet Valve Cleaning .....	19
Materials .....	10	<b>Troubleshooting</b> .....	<b>20</b>
<b>Install Tip/Guard Assembly</b> (if not installed) .....	<b>11</b>	<b>Technical Data</b> .....	<b>23</b>
		<b>Graco Standard Warranty</b> .....	<b>24</b>

## Important User Information

Read this before using your sprayer. See the Operation Manual provided with your sprayer for complete instructions on proper use and safety warnings.

**DO NOT RETURN THIS SPRAYER TO THE STORE!**  
If you experience problems, contact Graco Customer Service at [www.graco.com](http://www.graco.com).

Congratulations! You have purchased a high-quality paint sprayer made by Graco Inc. This sprayer is designed to provide superior spray performance with water-based and oil-based (mineral spirit-type) architectural paints and coatings. This user information sheet is intended to help you understand the types of materials that can and cannot be used with your sprayer.

Before using this equipment, be sure to read and follow the information on your container label and ask for a Material Safety Data Sheet (MSDS). The container label and MSDS will explain the contents of the material and the specific precautions related to it.

Paints, coatings and clean-up materials generally fit into one of the following **3 basic categories**:



**WATER-BASED:** The container label should indicate that the material can be cleaned up with soap and water. Your sprayer is compatible with this type of material. Your sprayer is **NOT** compatible with harsh cleaners such as chlorine bleach.







**OIL-BASED:** The container label should indicate that the material is combustible and can be cleaned up with mineral spirits or paint thinner. The MSDS must indicate that the flash point of the material is above 100° F. Your sprayer is compatible with this type of material. Use oil-based material outdoors or in a well-ventilated indoor area with a flow of fresh air. See the safety warnings in your Operation Manual.









**FLAMMABLE:** This type of material contains flammable solvents such as xylene, toluene, naphtha, MEK, lacquer thinner, acetone, denatured alcohol, and turpentine. The container label should indicate that this material is **FLAMMABLE**. This type of material is **NOT** compatible with your sprayer and **CANNOT** be used.

# Warnings

The following warnings are for the setup, use, maintenance, and repair of this equipment. The exclamation point symbol alerts you to a general warning and the hazard symbols refer to procedure-specific risks. When these symbols appear in the body of this manual, refer back to these Warnings. Product-specific hazard symbols and warnings not covered in this section may appear throughout the body of this manual where applicable.

 <b>WARNING</b>	
	<p><b>FIRE AND EXPLOSION HAZARD</b></p> <p>Flammable fumes, such as solvent and paint fumes, in work area can ignite or explode. To help prevent fire and explosion:</p> <ul style="list-style-type: none"> <li>• Sprayer generates sparks. Do not spray or flush with flammable liquids.</li> <li>• Use only water-based or oil-based (mineral spirit-type) materials with a flash point greater than 100° F (38° C).</li> <li>• Keep spray area well-ventilated. Keep a good supply of fresh air moving through the area.</li> <li>• Use oil-based material outdoors or in a well-ventilated indoor area with a flow of fresh air.</li> <li>• Do not spray or flush with combustible materials near an open flame or sources of ignition.</li> <li>• Paint or solvent flowing through the equipment is able to result in static electricity. Static electricity creates a risk of fire or explosion in the presence of paint or solvent fumes. Keep sprayer at least 10 cm away from objects while spraying or flushing.</li> <li>• Do not smoke in the spray area.</li> <li>• Do not operate light switches, engines, or similar spark producing products in the spray area.</li> <li>• Keep area clean and free of paint or solvent containers, rags, and other flammable materials.</li> <li>• Know the contents of the paints and solvents being sprayed. Read all Material Safety Data Sheets (MSDS) and container labels provided with the paints and solvents. Follow the paint and solvents manufacturer's safety instructions.</li> <li>• Fire extinguisher equipment shall be present and working.</li> </ul>
	<p><b>SKIN INJECTION HAZARD</b></p> <p>High-pressure spray is able to inject toxins into the body and cause serious bodily injury. In the event that injection occurs, <b>get immediate surgical treatment</b>.</p> <ul style="list-style-type: none"> <li>• Do not aim the sprayer at, or spray any person or animal.</li> <li>• Keep hands and other body parts away from the discharge. For example, do not try to stop leaks with any part of the body.</li> <li>• Always engage the trigger lock when not spraying. Verify the trigger lock is functioning properly.</li> <li>• Always use the nozzle tip guard. Do not spray without nozzle tip guard in place.</li> <li>• Use caution when cleaning and changing nozzle tips. In the case where the nozzle tip clogs while spraying, follow the <b>Pressure Relief Procedure</b> for turning off the unit and relieving the pressure before removing the nozzle tip to clean.</li> <li>• Do not leave the unit energized or under pressure while unattended. When the unit is not in use, turn off the unit and follow the <b>Pressure Relief Procedure</b> for turning off the unit.</li> <li>• Check parts for signs of damage. Replace any damaged parts.</li> <li>• This system is capable of producing 2000 psi. Use replacement parts or accessories that are rated a minimum of 2000 psi.</li> <li>• Do not carry the tool with a finger on the trigger.</li> <li>• Verify that all connections are secure before operating the unit.</li> <li>• Know how to stop the unit and bleed pressure quickly. Be thoroughly familiar with the controls.</li> </ul>
	<p><b>EQUIPMENT MISUSE HAZARD</b></p> <p>Misuse can cause death or serious injury.</p> <ul style="list-style-type: none"> <li>• Always wear appropriate gloves, eye protection, and a respirator or mask when painting.</li> <li>• Do not operate or spray near children. Keep children away from equipment at all times.</li> <li>• Do not overreach or stand on an unstable support. Keep effective footing and balance at all times.</li> <li>• Stay alert and watch what you are doing.</li> <li>• Do not operate the unit when fatigued or under the influence of drugs or alcohol.</li> <li>• Use only in dry locations. Do not expose to water or rain.</li> <li>• Use in well-lit areas.</li> </ul>

# ! WARNING

	<p><b>BATTERY HAZARD</b></p> <p>The battery may leak, explode, cause burns, or cause an explosion if mishandled. Contents of an open battery can cause severe irritation and/or chemical burns. If on skin, wash with soap and water. If in eyes, flush with water for at least 15 minutes and seek immediate medical attention.</p> <ul style="list-style-type: none"> <li>• Do not short-circuit the terminals of the battery.</li> <li>• Keep the battery away from fire.</li> <li>• Charge only with Graco approved charger as listed in this manual.</li> <li>• Do not expose to heat above 170° F (80° C).</li> <li>• Do not expose battery to water or rain.</li> <li>• Do not disassemble, crush, or penetrate the battery.</li> <li>• Follow local ordinances and/or regulations for disposal.</li> </ul>
	<p><b>CHARGER ELECTRIC SHOCK, FIRE AND EXPLOSION HAZARD</b></p> <p>Improper setup or usage can cause electric shock, fire, and explosion.</p> <ul style="list-style-type: none"> <li>• Charge only Graco 18V Lithium Ion batteries; other batteries may burst.</li> <li>• Use only in dry locations. Do not expose to water or rain.</li> <li>• If the supply cord is damaged, it must be obtained from the manufacturer to avoid a hazard.</li> <li>• Ensure that the outside surface of the battery is clean and dry before plugging into the charger.</li> <li>• Do not attempt to charge non-rechargeable batteries.</li> <li>• Place charger on flat non-flammable surfaces and keep away from flammable materials or fumes when recharging battery.</li> </ul>
	<p><b>PRESSURIZED ALUMINUM PARTS HAZARD</b></p> <p>Use of fluids that are incompatible with aluminum in pressurized equipment can cause serious chemical reaction and equipment rupture. Failure to follow this warning can result in death, serious injury, or property damage.</p> <ul style="list-style-type: none"> <li>• Do not use 1,1,1-trichloroethane, methylene chloride, other halogenated hydrocarbon solvents or fluids containing such solvents.</li> <li>• Many other fluids may contain chemicals that can react with aluminum. Contact your material supplier for compatibility.</li> </ul>
	<p><b>MOVING PARTS HAZARD</b></p> <p>Moving parts can pinch or amputate fingers and other body parts.</p> <ul style="list-style-type: none"> <li>• Keep clear of moving parts.</li> <li>• Do not operate equipment with protective guards or covers removed.</li> <li>• Pressurized equipment can start without warning. Before checking, moving, or servicing equipment, follow the <b>Pressure Relief Procedure</b> in this manual. Disconnect power.</li> </ul>
	<p><b>TOXIC FLUID OR FUMES HAZARD</b></p> <p>Toxic fluids or fumes can cause serious injury or death if splashed in the eyes or on skin, inhaled, or swallowed.</p> <ul style="list-style-type: none"> <li>• Read MSDS's to know the specific hazards of the fluids you are using.</li> <li>• Store hazardous fluid in approved containers, and dispose of it according to applicable guidelines.</li> </ul>
	<p><b>PERSONAL PROTECTIVE EQUIPMENT</b></p> <p>You must wear appropriate protective equipment when operating, servicing, or when in the operating area of the equipment to help protect you from serious injury, including eye injury, hearing loss, inhalation of toxic fumes, and burns. This equipment includes but is not limited to:</p> <ul style="list-style-type: none"> <li>• Protective eyewear, and hearing protection.</li> <li>• Respirators, protective clothing, and gloves as recommended by the fluid and solvent manufacturer.</li> </ul>

# Component Identification

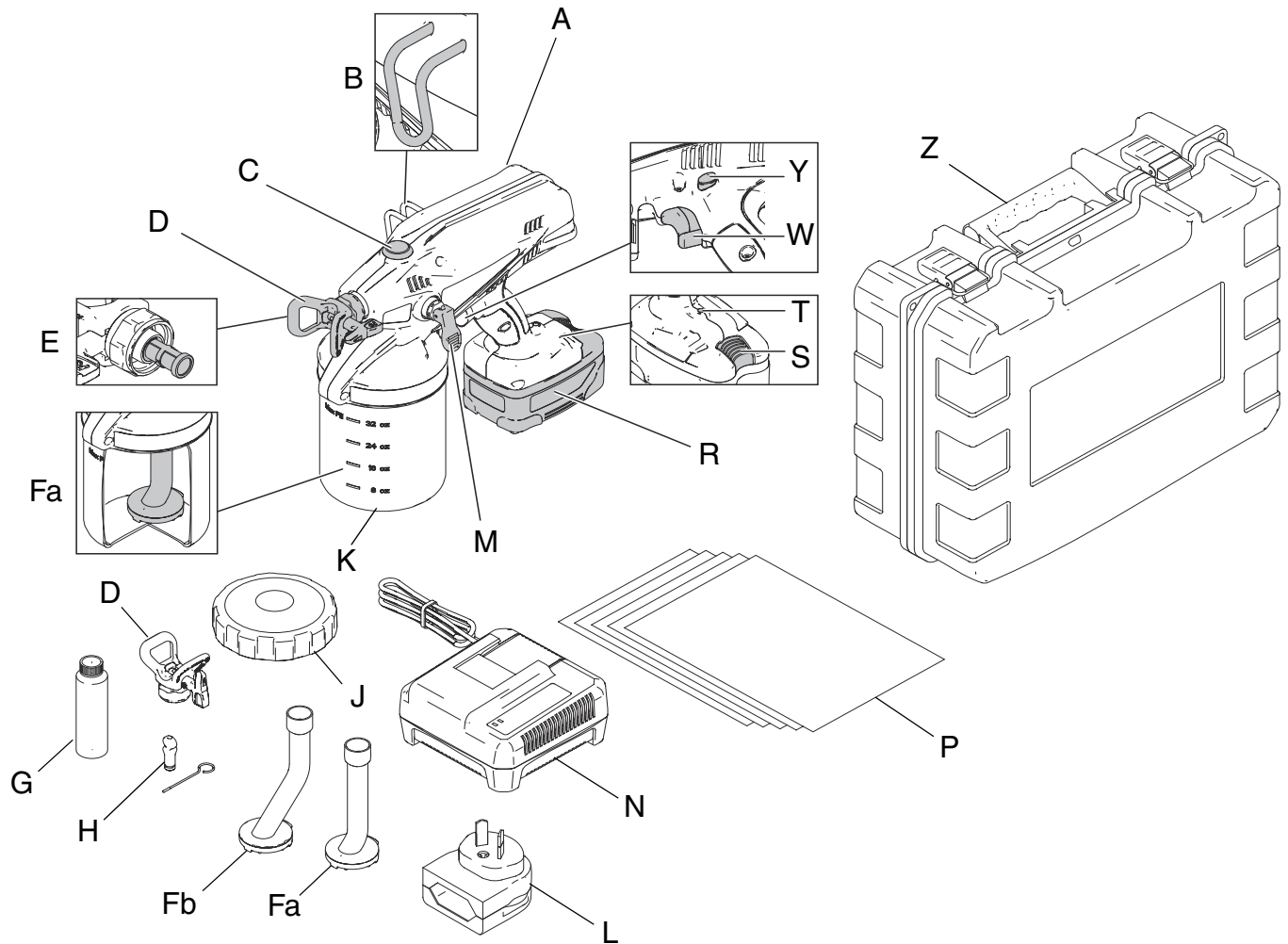

A	ProShot Cordless Paint Sprayer
B	Sprayer Hook
C	Outlet Valve Repair Access
D	ProShot Spray Tip/Guard Assembly (411, 515 included)
E	Tip Filter (*Reverse Threaded)
Fa	Standard Suction Tube (sprays ceilings and walls)
Fb	Specialized Suction Tube (sprays floors)
G	Pump Armor Concentrate (4 oz.)
H	Fine-Finish Optimizer with Storage/Cleaning Tool
J	Material Cup Cover and Seal

K	Material Cup (32 oz)
L	Power Cord Converter (258859 only)
M	Prime/Relief Valve
N	Lithium Ion Premium Power Battery Charger
P	Material Cup Liners (5 included)
R	Lithium Ion Premium Power Battery (2 included)
S	Battery Release Button
T	Battery Status Indicator Light
W	Sprayer Trigger
Y	Sprayer Trigger Lock
Z	ProShot Case

**\*NOTE:** Filter assembly is reverse-threaded. Turn left (or counter-clockwise) to tighten, turn right (or clockwise) to loosen.

# Common Procedures

## Pressure Relief Procedure

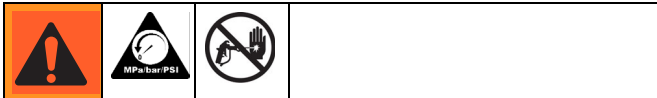

Do not operate or spray near children. Do not aim the sprayer at, or spray any person or animal. Keep hands and other body parts away from the front of the sprayer. For example, do not try to stop the paint flow with any part of the body.

This sprayer builds up an internal pressure of 2,000 psi during use. Follow this **Pressure Relief Procedure** whenever you stop spraying and before cleaning, checking, servicing, or transporting equipment to prevent serious injury.

1. Engage trigger lock.

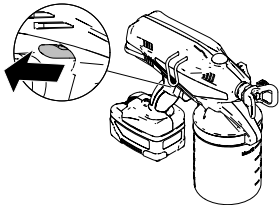

2. Put prime/relief valve UP to release pressure.

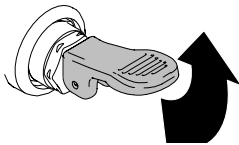

## Trigger Lock

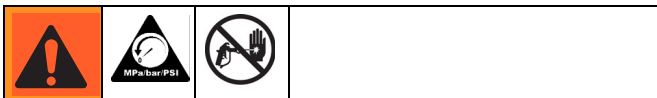

Always engage the trigger lock when you stop spraying to prevent the sprayer from being triggered accidentally by hand, or if dropped or bumped.

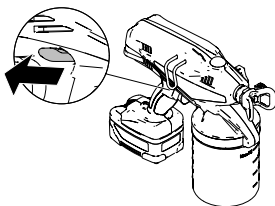

**Trigger Locked**

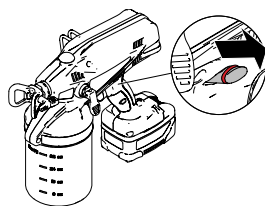

**Trigger Unlocked  
(red ring is visible)**

## Spray Tip Position



Always perform **Pressure Relief Procedure** before adjusting spray tip position.

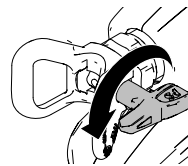

**Tip Forward  
(SPRAY position)**

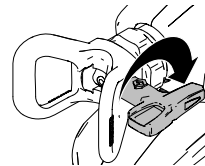

**Tip Reversed  
(UNCLOG position)**



## Prime/Relief Valve Position

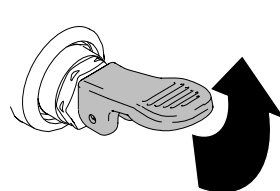
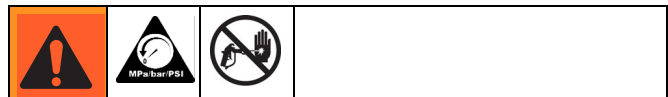

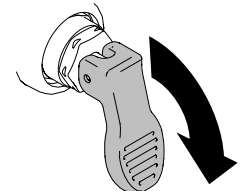

**UP position  
(Releases pump pressure)**



**DOWN position  
(Ready to spray)**

# Charging the Battery

		
Batteries may leak, explode, cause burns or cause an explosion if mishandled.		



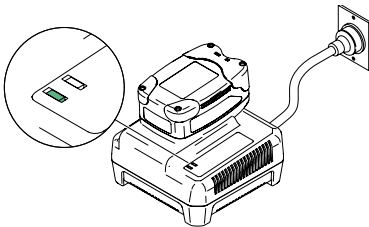

Batteries are initially 50% charged to provide optimum battery life and require charging before first use. It takes approximately 45 minutes to charge a dead battery to 80%, at which point it can be used. It will take approximately 75 minutes to fully charge a dead battery.

- Slide battery into charger as shown (light will turn on within 5 seconds).



**NOTE:** Batteries can remain in the charger, which automatically switches to maintenance mode. It is not recommended to store the battery in the charger for longer than one week.



## Charger Status Indicator Lights

Label	Appearance	Description
	Solid green light	Indicates a full charge. Use the battery or leave it in the charger. The automatic Maintenance Mode holds the batteries at full charge.
	Flashing green light	Battery is charging, indicates 80% charge. Battery can be used.
	Flashing red light	Battery is charging, indicates less than 80% charge. Do NOT use battery.
	Solid red light	Battery is too hot or too cold to charge and must cool down or warm up before charging. Leave battery in charger.

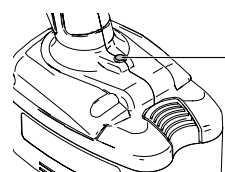
## Sprayer Status Indicator

Light	Appearance	Description
	No light	Normal operation.
	Solid red	Battery is low on power and needs to be charged, or battery is too cold and must warm up before spraying.
	Flashing red	Battery temperature is too high, or tip is clogged. See <b>Troubleshooting</b> , page 20.

**NOTE:** The indicator light is only visible when sprayer trigger is engaged. You must **squeeze and hold the trigger** to see the Sprayer Status Indicator.

		
To reduce the risk of electric shock, only use Graco batteries with the Graco charger. Do not insert any foreign objects into the adapter cup.		

**NOTE:** The amount sprayed with each battery varies depending on material, tip size, battery charge, and battery temperature. 1 battery fully charged will spray approximately 1 gallon when using the 515 tip with latex paint. You will get less when using a smaller tip or thinner material.

**NOTE:** The charger supplied with model 258859 comes with a power cord adapter connected to the power cord. To switch from the AS3112 connector to the 2-pin Euro CEE7 connector, pull off the adapter.

<b>NOTICE</b>
Do not place a wet battery in the charger. Damage to equipment will occur.

## Setup

<p><b>Use only water-based or oil-based (mineral spirit-type) materials with flash point greater than 100° F (38° C).</b> Do not use materials which state “FLAMMABLE” on the packaging. For more information about your material, request MSDS from distributor or retailer.</p> <p><b>Spraying certain materials may cause static build-up in the sprayer that can result in static shock to the user.</b> If this occurs, first ensure the material has a flash point greater than 100° F (38° C) and does not state that it is FLAMMABLE anywhere on the package. If still feeling a static shock, the material likely contains a non-mineral spirits fluid such as, but not limited to, xylene, toluene, or naphtha, which can build up static. Switch to an alternative material.</p> <p>Use oil-based material outdoors or in a well-ventilated indoor area with a flow of fresh air.</p> <p><b>Keep spray area well-ventilated.</b> Keep a good supply of fresh air moving through the area.</p>		

### NOTICE

Your sprayer is **NOT** compatible with harsh cleaners such as chlorine bleach. Using these cleaners will cause damage to the sprayer.

## Suction Tube Selection

This sprayer comes with two different suction tubes.

### Standard Suction Tube (sprays ceilings and walls):

When spraying walls, the inlet of the suction tube should be aimed at the front of the material cup.

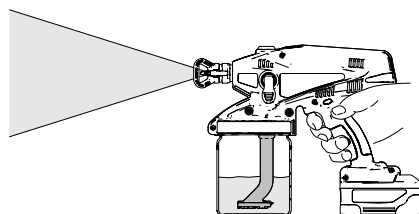

When spraying ceilings, the inlet of the suction tube should be aimed at the back of the material cup (towards the trigger).

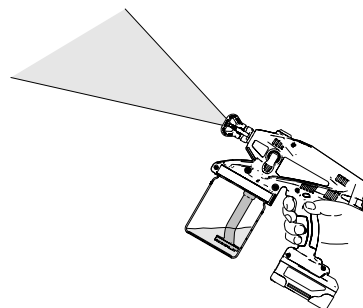

### Specialized Suction Tube (sprays floors):

When spraying floors, the inlet of the suction tube should be aimed at the front of the material cup (towards Spray Tip/Guard Assembly).

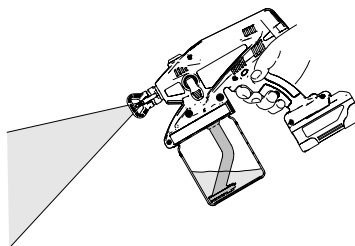

**NOTE:** If the sprayer is angled or tilted too far, the suction tube will lose contact with the material and the sprayer will stop spraying.

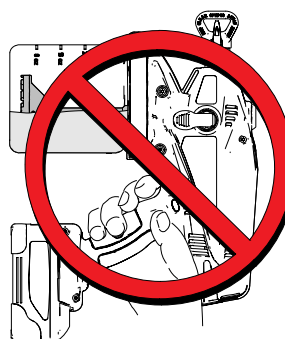



## Spraying Stains or Clear Coats (Fine-Finish Optimizer)

The Fine-Finish Optimizer should be installed and used when spraying thin material such as stain or clear coats. The Fine-Finish Optimizer restricts the material flow resulting in a finer quality finish.

### Installation

1. Remove material cup and suction tube.

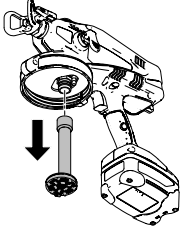

2. Push Fine-Finish Optimizer into pump inlet until completely engaged and re-install suction tube.

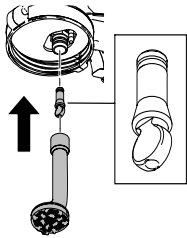

### Cleanup/Storage

Be sure to remove and clean the Fine-Finish Optimizer immediately after use. Store the Fine-Finish Optimizer on the Storage/cleaning Tool supplied to keep the hole clear of dried material.

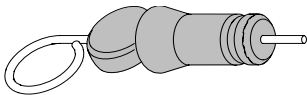

## Sprayer Setup

This sprayer arrives from the factory with a small amount of test material in the system. **It is important that you flush this material from the sprayer before using it for the first time:**

1. Fill material cup with water and thread onto sprayer.

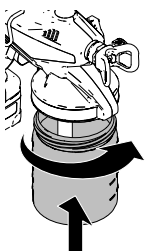

2. Put prime/relief valve to UP position, then hold trigger in for 10 seconds.

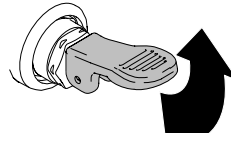

3. Put prime/relief valve DOWN to spray position.

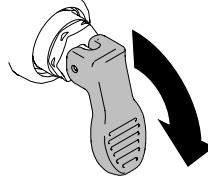

4. Reverse spray tip to UNCLOG position and trigger sprayer into a waste area.

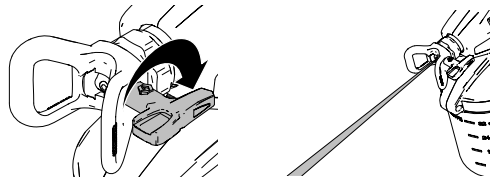

5. Engage trigger lock and put prime/relief valve UP to release pressure.



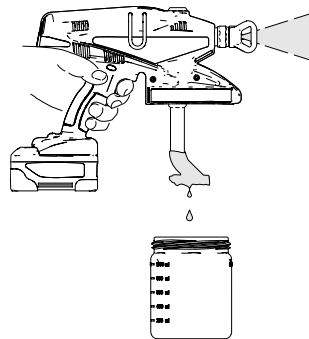

6. Unscrew and remove material cup.

7. Disengage trigger lock, put prime/relief valve DOWN, hold sprayer slightly above material cup, and pull trigger to discharge fluid from pump.



8. Discard material in cup.

## Materials

		
<p><b>Use only water-based or oil-based (mineral spirit-type) materials with flash point greater than 100° F (38° C).</b> Do not use materials which state “FLAMMABLE” on the packaging. For more information about your material, request MSDS from distributor or retailer.</p> <p><b>Spraying certain materials may cause static build-up in the sprayer that can result in static shock to the user.</b> If this occurs, first ensure the material has a flash point greater than 100° F (38° C) and does not state that it is FLAMMABLE anywhere on the package. If still feeling a static shock, the material likely contains a non-mineral spirits fluid such as, but not limited to, xylene, toluene, or naphtha, which can build up static. Switch to an alternative material.</p> <p>Use oil-based material outdoors or in a well-ventilated indoor area with a flow of fresh air.</p> <p><b>Keep spray area well-ventilated.</b> Keep a good supply of fresh air moving through the area.</p>		

- When spraying **water-based** materials, flush the sprayer thoroughly with water.
- When spraying **non-water-based** materials, flush the sprayer thoroughly with mineral spirits or compatible, oil-based flushing fluid.

### Starting a New Job (or Refilling the Cup)

1. Engage trigger lock and put prime/relief valve UP to release pressure.

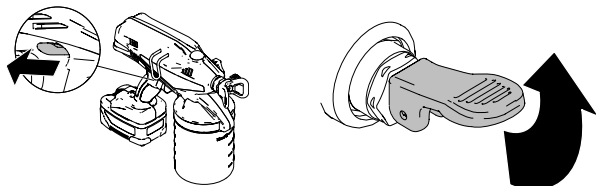

2. Use the Fine-Finish Optimizer cleaning tool to lightly push on inlet valve to make sure it moves up and down freely.

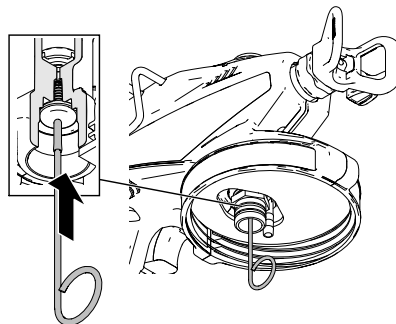

3. Install material cup liner, fill with material, and thread onto sprayer.

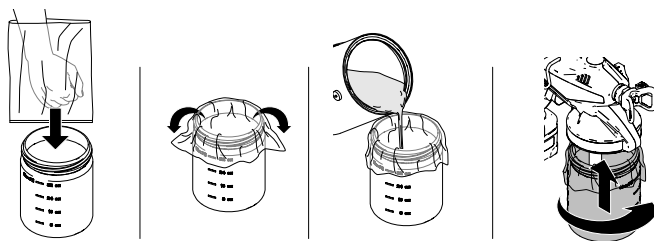

4. To prime pump, disengage trigger lock and trigger sprayer for 10 seconds. Then release trigger and put prime/relief valve DOWN to spray position.

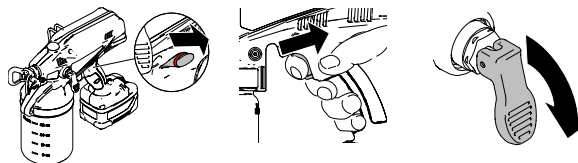

5. Reverse spray tip to UNCLOG position and spray into waste area for five seconds. Then rotate tip back to SPRAY position. **NOTE:** Failure to perform this operation could result in poor spray pattern.

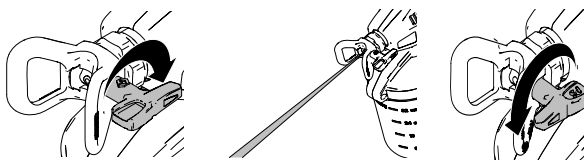

**NOTE:** If sprayer fails to prime, follow **Alternative Priming Method** (page 18) and/or **Inlet Valve Cleaning** (page 19).

# Install Tip/Guard Assembly (if not installed)

## Reversible Tip Selection Chart

MATERIALS		
*Thin	Medium	Heavy
Thin stains, semi-transparent stains	Enamels, solid stains, thin latex	Heavy latex
211, 411	213, 413	315, 515, 517

\*Install **Fine-Finish Optimizer**, see page 9.

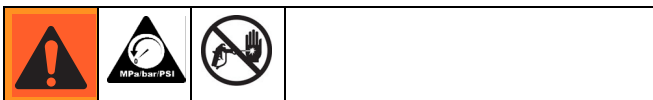

- Engage trigger lock and put prime/relief valve UP to release pressure. Then remove Tip/Guard Assembly.

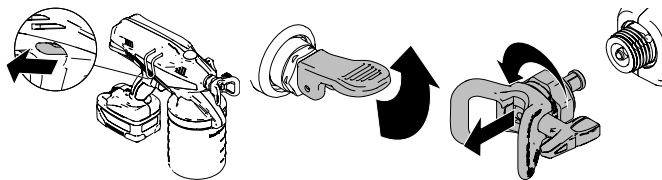

- Install filter to Spray Tip/Guard Assembly (make sure filter is fully installed into sprayer). **NOTE:** Filter assembly is reverse-threaded. **Turn left** (or counter-clockwise) to install. **Turn right** (or clockwise) to remove.

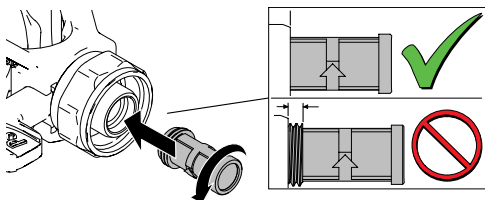

### NOTICE

Make sure filter is completely screwed into the Tip/Guard Assembly to avoid damage to the filter.

- Screw Tip/Guard Assembly onto sprayer. Tighten retaining nut until completely engaged with sprayer.

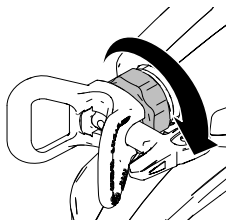

### NOTICE

The tip is permanently attached to the Tip/Guard Assembly. Removal will result in damage.

# Getting Started with Basic Techniques

Use a piece of scrap cardboard to practice these basic spraying techniques before you begin spraying the surface.

- Hold sprayer 10 in. (25 cm) from surface and aim straight at surface. Tilting sprayer to direct spray angle causes an uneven finish.

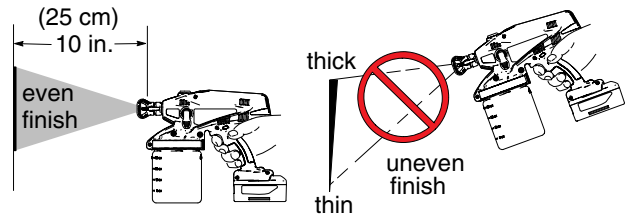

- Flex wrist to keep sprayer pointed straight. Fanning sprayer to direct spray at angle causes uneven finish.

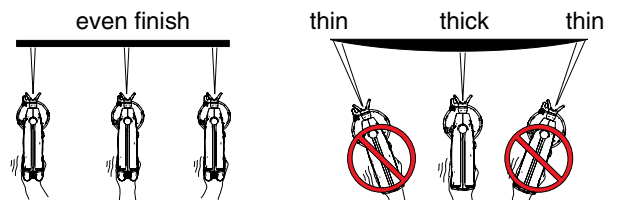

**NOTE:** How fast you move the sprayer will affect spray application. If material is pulsating, you are moving too fast. If material drips, you are moving too slow. See **Troubleshooting**, page 20.

## Triggering Sprayer

Pull trigger after starting stroke. Release trigger before end of stroke. Sprayer must be moving when trigger is pulled and released.

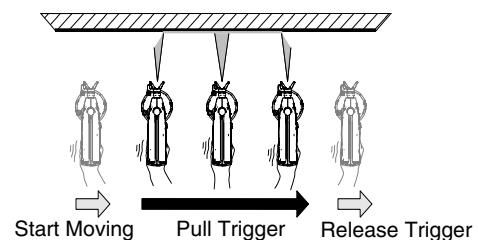

## Aiming Sprayer

Aim tip of sprayer at bottom edge of previous stroke, overlapping each stroke by half.

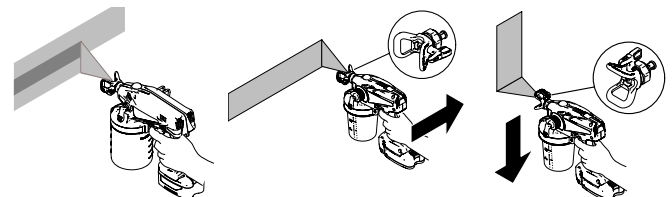

# Unclogging Spray Tip/Guard Assembly

<p>Do not operate or spray near children. Do not aim the sprayer at, or spray any person or animal. Keep hands and other body parts away from the discharge. For example, do not try to stop leaks with any part of the body.</p>		

1. To unclog tip obstruction, engage trigger lock and pull relief valve UP to release pressure.

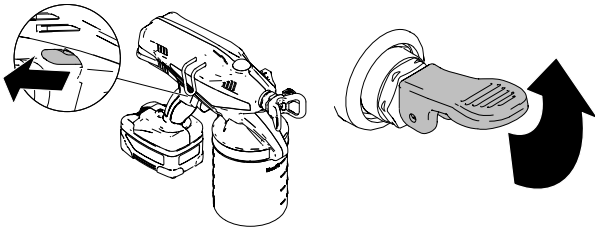

2. Reverse spray tip to UNCLOG position.

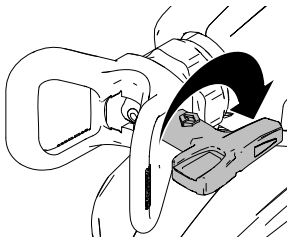

3. Aim sprayer at waste area, disengage trigger lock, and put prime/relief valve DOWN to spray position. Pull trigger to clear clog.

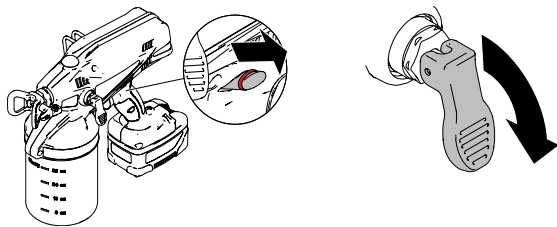

4. Engage trigger lock. Put prime/relief valve UP to release pressure and rotate spray tip back to SPRAY position.

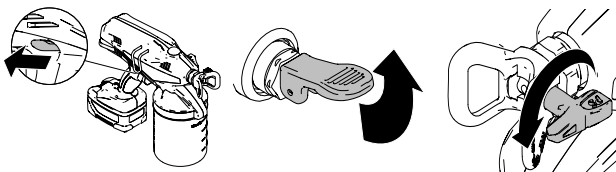

5. Disengage trigger lock, put prime/relief valve DOWN to spray position, and resume spraying.

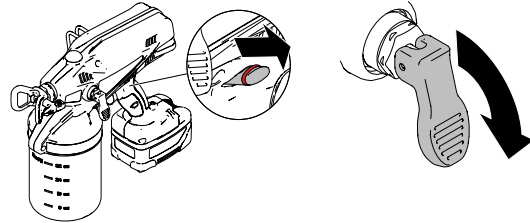

6. If tip is still clogged, you may have to repeat steps 1 - 5 and rotate the tip from SPRAY to UNCLOG several times. Repeat step 1 to release pressure, remove and clean filter, or replace with new tip assembly.

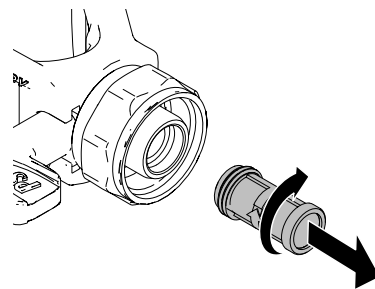

**NOTE:** Filter assembly is reverse-threaded:  
**Turn left** (or counter-clockwise) to install.  
**Turn right** (or clockwise) to remove.

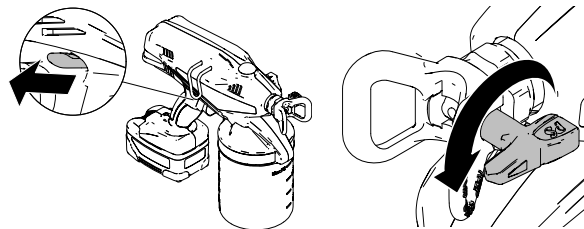

7. If obstruction is cleared, engage trigger lock and rotate arrow-shaped handle back to SPRAY position.



# Shutdown and Cleaning

**NOTICE**  
Failure to properly clean sprayer after each use will result in hardened materials, damage to the sprayer, and the warranty will no longer be valid.

## Flushing Sprayer

		
<p><b>Use only water-based or mineral spirit-type materials with flash point greater than 100° F (38° C).</b> Do not use materials which state "FLAMMABLE" on the packaging. For more information about your material, request MSDS from distributor or retailer.</p> <p><b>Spraying certain materials may cause static build-up in the sprayer that can result in static shock to the user.</b> If this occurs, first ensure the material has a flash point greater than 100° F (38° C) and does not state that it is FLAMMABLE anywhere on the package. If still feeling a static shock, the material likely contains a non-mineral spirits fluid such as, but not limited to, xylene, toluene, or naphtha, which can build up static. Switch to an alternative material.</p> <p>Use oil-based material outdoors or in a well-ventilated indoor area with a flow of fresh air.</p> <p><b>Keep spray area well-ventilated.</b> Keep a good supply of fresh air moving through the area.</p>		

**NOTICE**  
**Protect the internal parts of this sprayer from water.** Do not submerge the sprayer in cleaning fluid. Openings in shroud allow cooling of mechanical parts and electronics inside. If water gets into these openings, the sprayer could malfunction or become permanently damaged.

1. Engage trigger lock and pull relief valve UP to release pressure.

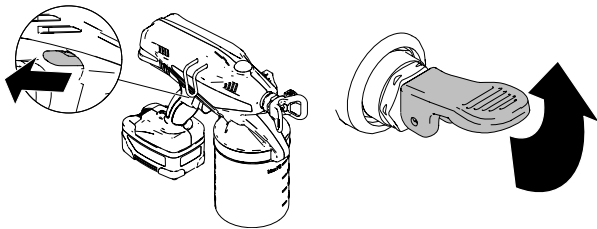

2. Remove material cup and properly dispose cup liner or excess material.

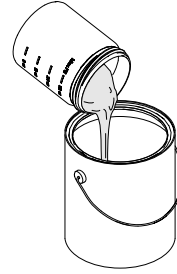

3. Remove and clean sprayer intake tube and screen with water (or flushing fluid) and a brush every time you flush the sprayer. Reconnect intake tube.

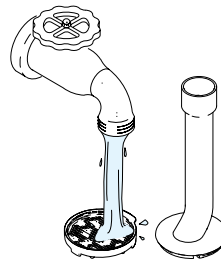

4. Clean cup if not using a liner, and fill with water or appropriate flushing fluid.



5. Reconnect material cup and shake sprayer to move clean water around and clean all areas inside of cup.

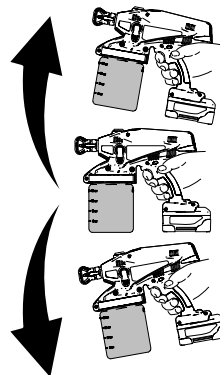

6. Disconnect trigger lock and trigger sprayer for approximately 15 seconds. Engage trigger lock.

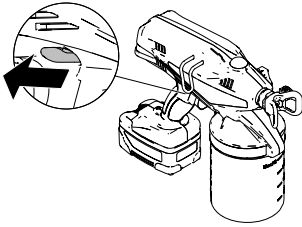

7. Discard contaminated fluid and refill with appropriate flushing fluid.

8. Disengage trigger lock, reverse tip to UNCLOG position, and pull trigger for 5 seconds to prime sprayer.



9. Put prime/relief valve DOWN to spray position. Trigger sprayer into waste area until no paint appears in water or flushing fluid.

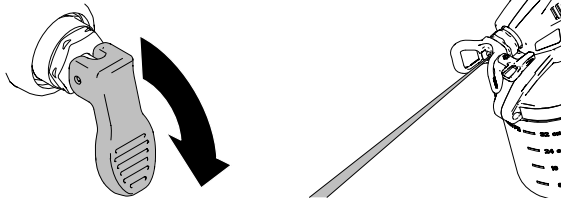

10. Engage trigger lock and put prime/relief valve UP to release pressure.

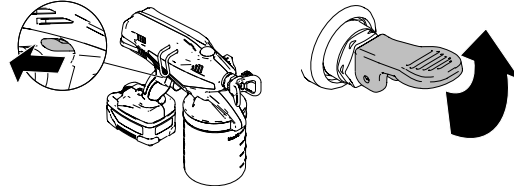

11. Remove material cup and discard used fluid.

12. Use a soft brush to clean the black rubber inlet seal. If the vent holes become clogged, use the Fine Finish optimizer cleaning tool or a paper clip to clear the holes.

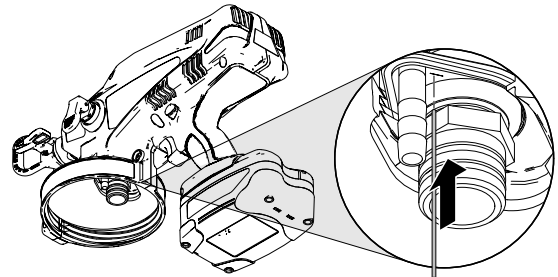
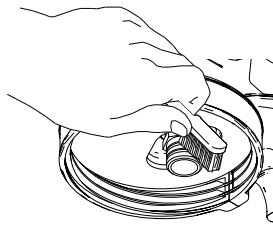

13. Remove Spray Tip/Guard Assembly and clean with water or flushing fluid. A soft brush can be used to loosen and remove dried material if needed.



<p>To avoid serious injury or damage to equipment, do not expose the sprayer electronics to flushing solvents. Keep sprayer <b>at least 10 in.</b> above the rim of the container when flushing.</p>		
<p>Keep spray area well-ventilated. Keep a good supply of fresh air moving through the area.</p>		

<b>NOTICE</b>
<p>The tip is permanently attached to the guard. Removing the tip from the guard will result in damage to the tip assembly.</p>

14. Replace tip assembly.

15. If you used the Fine-Finish Optimizer, remove and clean optimizer with water (or flushing fluid) and a brush. Reconnect intake tube.

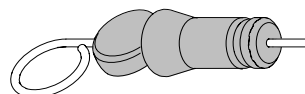

## Cleaning Sprayer Exterior

- Wipe paint off outside of sprayer using a soft cloth moistened with water or flushing fluid. Do NOT submerge the sprayer.



## Tips

- Tips will require replacement depending on abrasiveness of paint.
- Do not spray with worn tip. See **Troubleshooting**, page 20.

## Storage

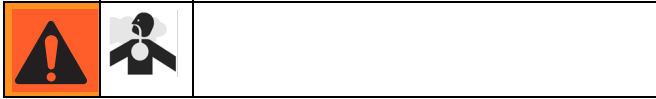

### NOTICE

Failure to store with sprayer with Pump Armor will result in operational problems the next time you spray. Always circulate Pump Armor through the sprayer after cleaning. Water left in the sprayer will corrode and damage the pump.

- Dilute 4 oz. bottle of Pump Armor Concentrate with an additional 4 oz. of water in material cup.

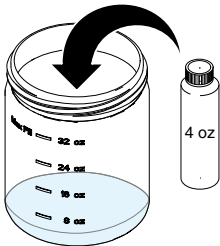

- Thread cup into sprayer, put prime/relief valve to UP position and squeeze sprayer trigger for approximately 10 seconds.

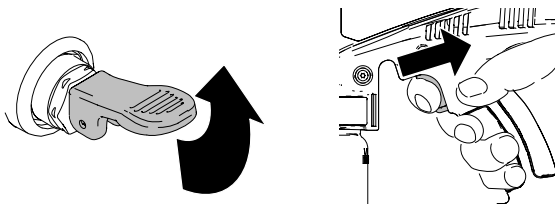

- Reverse spray tip to UNCLOG position, put prime/relief valve DOWN to spray position, and aim sprayer into waste area. Pull trigger for 1-2 seconds.

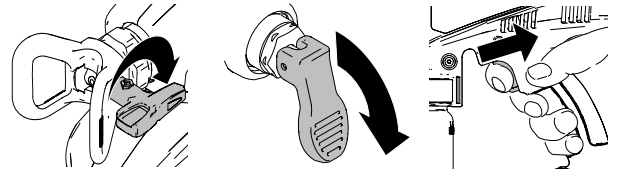

- Properly dispose of used Pump Armor mixture from material cup and rinse cup with water.

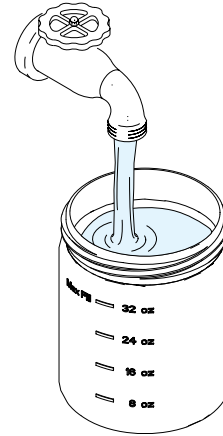

- Store sprayer indoors in a cool, dry place. Store in an **upright position only**.

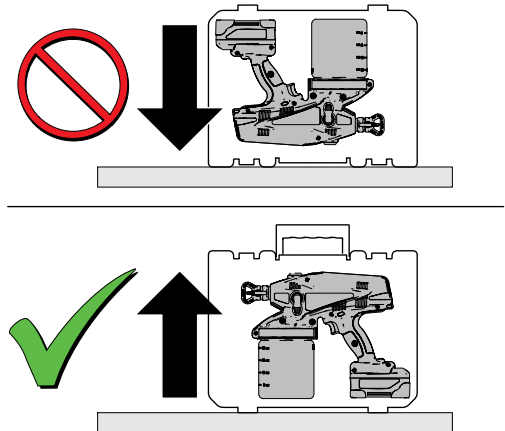

**NOTE:** For prolonged battery life, lithium batteries should be stored at half charge in an environment below 90° F (32° C).

# Replacement Parts and Kits

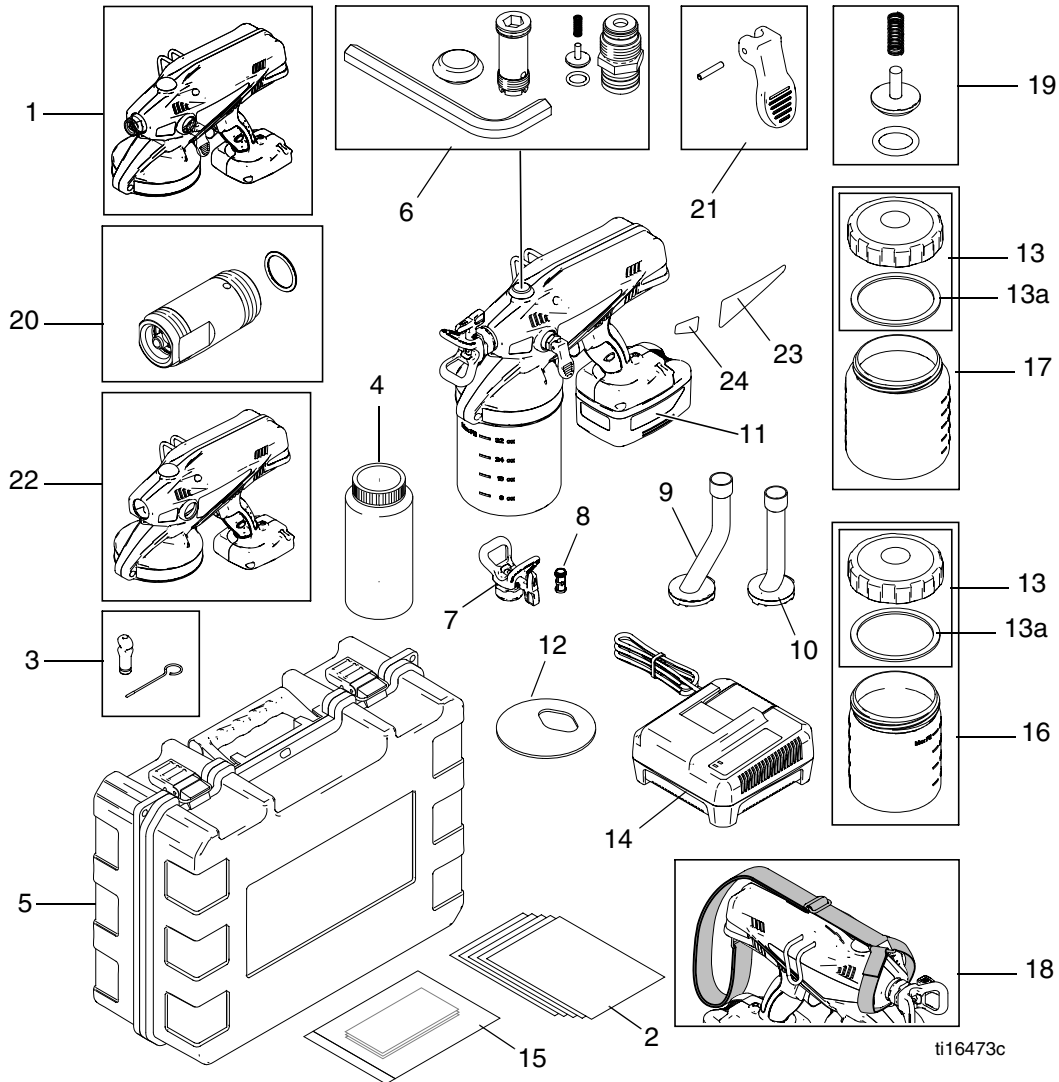

ti16473c

Ref. Part	Description
1 262367	Sprayer, replacement (no tip, battery, suction tube, or material cup)
2 16D562	Liner, replacement (10 pack)
3 24F045	Fine Finish Optimizer (with Cleaning Tool) 2-Pack
4 243103	Pump Armor (32 oz.)
5 24F042	Storage Case
6 16D563	Repair Kit (includes inlet/outlet valve wrench)
7	ProShot Tip/Guard Assembly
PST211	211
PST213	213
PST315	315
PST411	411 (included with sprayer)
PST413	413
PST515	515 (factory-installed on sprayer)
PST517	517
8	Tip Filter
24E376	Kit, 1-pack
24F039	Kit, 3-pack
9 24F044	Specialized Suction Tube with screens and o-rings (for spraying floors)
10 24F043	Standard Suction Tube with screens and o-rings (for walls and ceilings)
11 16D558	Lithium Ion Premium Power Battery

Ref. Part	Description
12 16E403	Sprayer Cup Seal
13 24D425	Cover with seal (included in 16 and 17)
13a 16C650	Material Cup Cover Seal (included in 16 and 17)
14 16D559	Lithium Ion Battery Charger (120 VAC)
16G615	Lithium Ion Battery Charger (240 VAC)
15 ▲24E609	Warning Labels Kit (ENG/FRA/SPA)
▲24H616	Warning Labels Kit (SPA/POR/ITA)
16 16D560	Material Cup (32 oz) cover and seal
17 16D561	Material Cup (48 oz) cover and seal
18 24E377	Shoulder Strap
106553	Suction Tube o-ring (not shown)
19 262602	Inlet Valve Kit
20 262437	Needle Assembly Kit
21 262601	Prime Valve Handle
22 262677	Enclosure, replacement, kit (Includes enclosure with hook, screws, cup gasket, status indicator lens, air filter, Made-In-USA label, and access plug) product labels NOT included
23 16E119	Label, brand, ProShot
24 16E964	Label, brand, Hand Held

▲ Replacement Danger and Warning labels, tags, and cards are available at no cost.



# ProShot Repair Kit

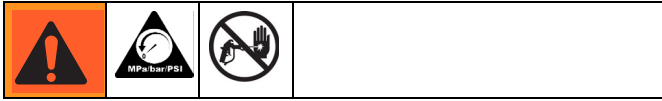

## Outlet Valve Fitting

**NOTE:** Before doing any repair to pump, perform **Flushing Sprayer** procedure, page 13.

### Removal

1. Engage trigger lock and pull relief valve UP to release pressure.

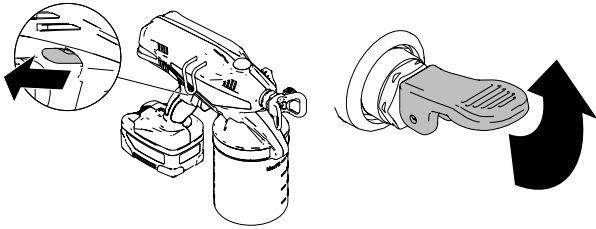

2. Remove battery.

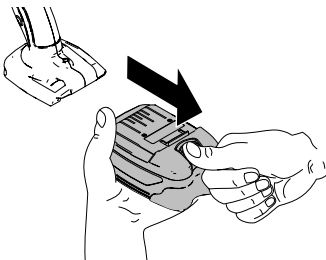

3. Remove pump outlet cap.

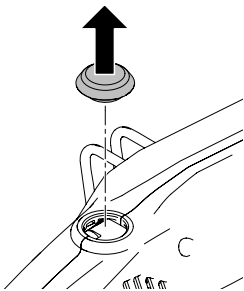

4. Use tool (supplied) to loosen and remove outlet valve fitting.

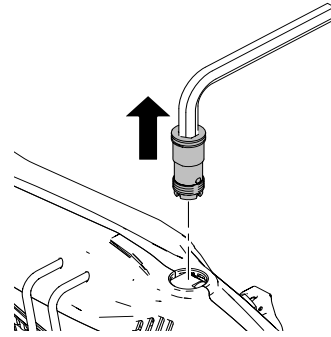

### Installation

1. Screw outlet valve fitting into threads. Use tool (supplied) and tighten to 8 ft-lb.

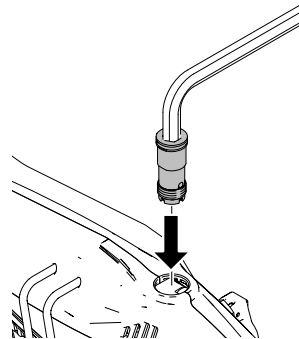

2. Press new pump outlet cap into place.

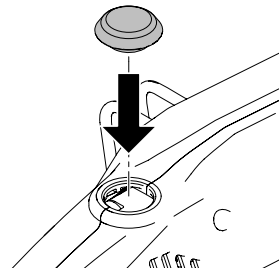

# Alternate Priming Method

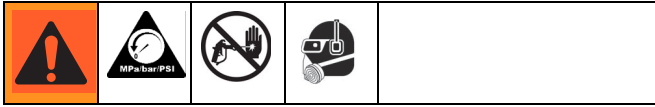

1. Engage trigger lock and put prime/relief valve UP to release pressure.

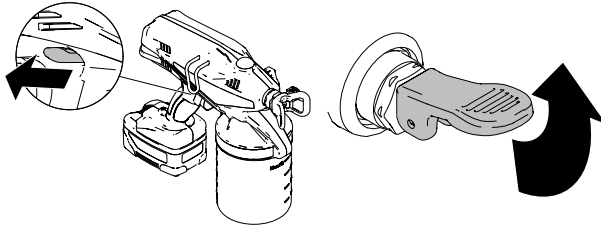

2. Remove material cup and fill with flushing material.

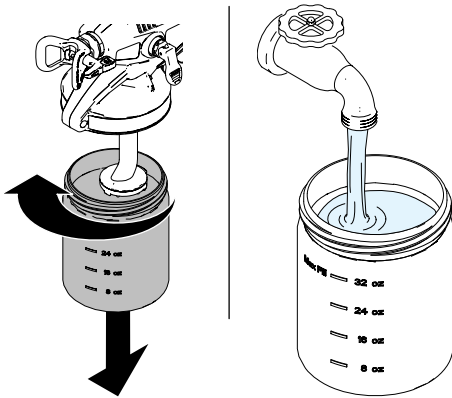

3. With sprayer in prime mode, turn sprayer upside-down, remove strainer and slowly pour flushing material into the intake tube until full.

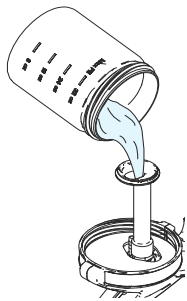

4. Hold sprayer above sink or waste area, disengage the trigger lock, and quickly trigger sprayer until material comes out of the drain tube.

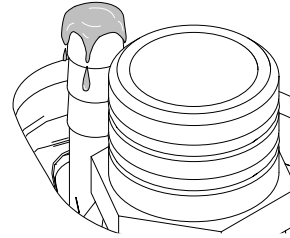

**NOTE:** Material can shoot out of the drain tube when performing this procedure. Be sure to wear appropriate safety equipment and point drain tube away from yourself when pulling the trigger,

5. Thread the material cup back onto sprayer.

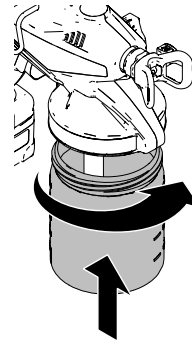

6. Trigger the gun for 10 seconds then release the trigger and put the prime/relief valve DOWN to spray position.

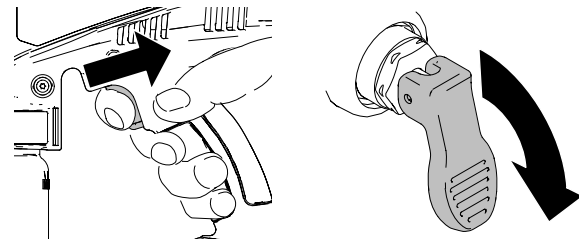

7. Reverse spray tip to UNCLOG position and spray into waste area for five seconds to ensure sprayer has primed.

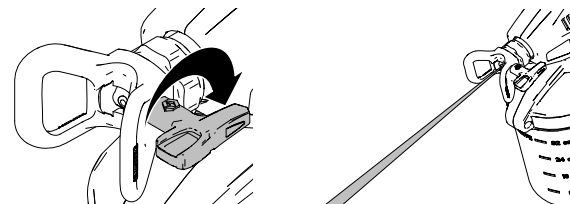

8. Sprayer is now ready to spray. Follow **Starting New Job** instructions on page 10.

## Inlet Valve Cleaning

### Removal

1. Engage trigger lock and pull relief valve UP to release pressure.

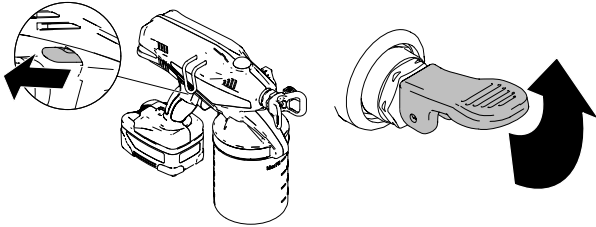

2. Remove material cup and suction tube.

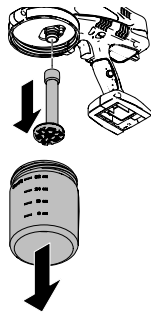

3. Hold sprayer upside-down and use wrench or socket to loosen and remove inlet fitting, inlet valve, and spring.

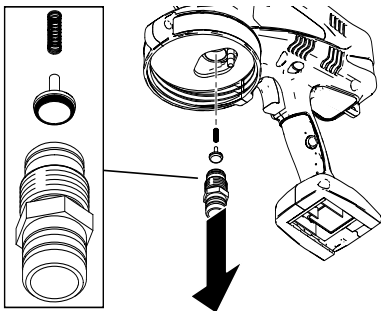

**NOTE:** Make sure the spring also comes out. Use needle-nose pliers to remove if needed. Inlet cavity should be completely empty (as shown below).

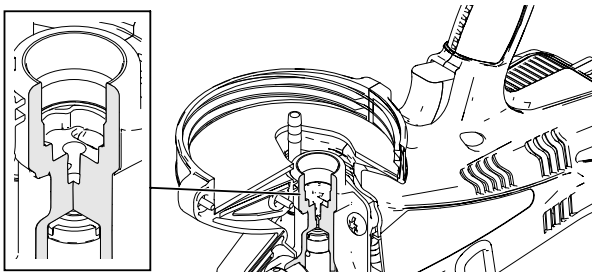

4. Clean as much excess material from pump cavity as possible. Make sure you also clean spring (a), o-ring (c), and top of inlet fitting (d).

### Installation

**NOTE:** Before installing, make sure o-ring (c) is installed on inlet valve (b).

1. Place inlet valve (b) with spring (a) on top of inlet fitting (d). Push inlet fitting up into pump cavity.

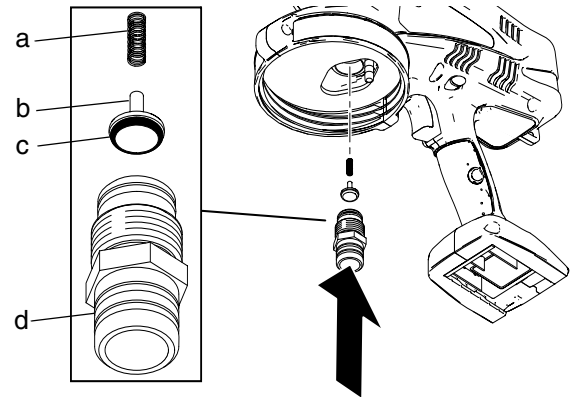

2. Hold inlet in place and turn sprayer upside-down. Remove inlet fitting and visually check to see that inlet valve has seated correctly.

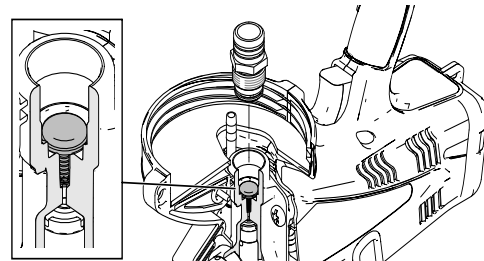

3. Replace inlet fitting and use wrench and socket to tighten to 10 ft-lb.

**NOTICE**  
Do **NOT** over-tighten inlet fitting. Damage to the equipment will occur.

4. Use the Fine-Finish Optimizer cleaning tool to lightly push on inlet valve to make sure it moves up and down freely.

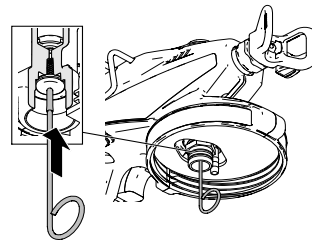

# Troubleshooting







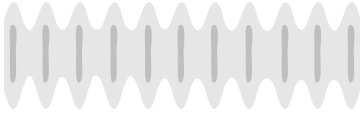

Check everything in this Troubleshooting Table before you bring the sprayer to an authorized service center.

Problem	Cause	Solution
ProShot makes no sound when trigger is pulled	Trigger is locked.	Disengage trigger lock. See page 6.
	Status Indicator Light is solid RED when triggering, indicating that the battery charge is low or the battery is too cold.	Replace with charged battery and place old battery in charger or allow battery to warm up.
	Status Indicator Light is flashing RED when triggering, indicating that the battery is too hot to operate.	Allow battery to cool.
ProShot makes sound but no material is sprayed when trigger is pulled	Status Indicator Light does not light when sprayer is triggered.	Battery is not installed or is damaged.
	Sprayer is not primed.	Prime the pump. See <b>Starting a new Job (or Refilling the Cup)</b> , page 10. If sprayer fails to prime, follow the <b>Inlet Valve Cleaning</b> procedure, page 19 and/or <b>Alternate Priming Method</b> , page 18.
	Prime/relief valve is in UP position.	Pull valve DOWN to spray position.
	Suction Tube is missing or improperly installed.	Make sure Suction Tube is properly installed.
	Inlet valve is stuck from material residue left in sprayer.	Use a pencil or thin rod to lightly push on inlet valve to make sure it moves up and down freely. See <b>Inlet Valve Cleaning</b> , page 19.
	Tip is not in SPRAY position.	Turn tip to SPRAY position.
	Tip is clogged.	See <b>Unclogging Tip/Guard Assembly</b> , page 12.
	Suction Tube screen is clogged or vent holes in black rubber inlet seal are clogged.	See <b>Shutdown and Cleaning</b> , page 13.
	Sprayer has been tilted too far and suction tube has lost contact with material.	Make sure cup is filled with material. Do not tilt the cup too far. Prime the pump. See <b>Starting a new Job (or Refilling the Cup)</b> , page 10.
	No or low material in cup.	Refill cup with material.
	Tip filter is clogged.	Remove and clean tip filter. See <b>Unclogging Tip/Guard Assembly</b> , page 12.
	Fine Finish Optimizer is installed while using an incompatible material.	Make sure compatible material is being used. See <b>Reversible Tip Selection Chart</b> , page 11.
	Suction Tube o-rings are damaged or missing.	Replace Suction Tube and o-rings.
	Pump is clogged, frozen, or has debris inside.	See <b>ProShot Repair</b> , page 17.
Sprayer has reached maximum life.	<b>ProShot only:</b> purchase repair kit. All other models should be replaced.	
Material is leaking from hole in front of sprayer.	Replace sprayer.	

Problem	Cause	Solution
ProShot sprays with poor results	Tip is partially clogged	See <b>Unclogging Tip/Guard Assembly</b> , page 12.
	Tip is not in correct position	Rotate tip to SPRAY position.
	Incorrect tip for application of material.	See <b>Reversible Tip Selection Chart</b> , page 11.
	Tip filter is partially clogged	Clean or replace filter. See page 12.
	Suction Tube screen is partially clogged.	Clean or replace Suction Tube. See page 13.
	Fine Finish Optimizer is partially clogged.	Clean or replace Fine Finish Optimizer. See page 9.
	Fine Finish Optimizer is installed while using an incompatible material.	Make sure compatible material is being used. See <b>Reversible Tip Selection Chart</b> , page 11.
	Tip is worn or damaged	Replace tip. See <b>Install Tip/Guard Assembly</b> , page 11.
Inlet or Outlet Valves are worn.	See <b>ProShot Repair</b> , page 17.	
Paint leaks from sprayer trigger area.	Sprayer has reached its maximum life.	Replace sprayer.
Battery is discharged but charger still displays green light when battery is inserted.	Damaged battery.	Replace battery.

### Spray Pattern Diagnostics

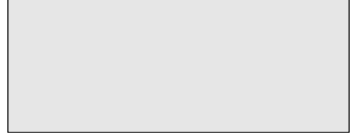
Problem	Cause	Solution
Spray pattern is pulsating: 	Fine Finish Optimizer is installed while using an incompatible material.  Operator is moving too fast while spraying.	Make sure material is compatible. See <b>Reversible Tip Selection Chart</b> , page 11.  Slow speed of movement.
Spray pattern has tails: 	Fine Finish Optimizer is installed while using an incompatible material.  Fine Finish Optimizer is partially clogged.  Material not compatible with sprayer.  Inlet or Outlet Valves are worn.	Make sure compatible material is being used. See <b>Reversible Tip Selection Chart</b> , page 11.  Clean or replace Fine Finish Optimizer. See page 9.  Switch material.  See <b>ProShot Repair</b> , page 17.
Spray pattern has dripping: 	Sprayer is moving too slow for material.  Sprayer is too close to target surface.  Holding trigger while changing spray direction.  Incorrect tip for application of material.  Tip is worn or damaged.	Move sprayer faster while spraying.  Move sprayer away from surface (10 in).  Release trigger when changing directions.  See <b>Reversible Tip Selection Chart</b> , page 11.  Replace tip. See <b>Install Tip/Guard Assembly</b> , page 11.

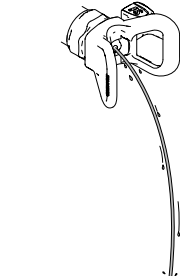
Problem	Cause	Solution
Spray pattern is too narrow: 	Sprayer is too close to target surface. Incorrect tip for application of material. Tip is worn or damaged.	Move sprayer away from surface (10 in). See <b>Reversible Tip Selection Chart</b> , page 11. Replace tip. See <b>Install Tip/Guard Assembly</b> , page 11.
Spray pattern is too wide: 	Sprayer is too far away from target surface. Incorrect tip for application of material.	Move sprayer closer to surface. See <b>Reversible Tip Selection Chart</b> , page 11.
Spray pattern “spits” at the end: 	Excess material has accumulated on Spray Tip/Guard Assembly. Tip filter is partially clogged. Tip/Guard Assembly not threaded completely onto sprayer. Seat is worn.	See <b>Shutdown and Cleaning</b> , page 13. Clean or replace filter. See page 12. See <b>Install Tip/Guard Assembly</b> , page 11. Replace Spray tip.
Tip continues to drip or ooze material after trigger is released: 	ProShot sprayer is worn out.	Replace sprayer.
Spray pattern does not adequately cover target surface	Fine Finish Optimizer is installed while using an incompatible material. ProShot sprayer is worn out.	Make sure compatible material is being used. See <b>Reversible Tip Selection Chart</b> , page 11. Replace sprayer.

# Technical Data

<b>Sprayer:</b>	<b>258865</b>	<b>258859</b>
Maximum working pressure	2000 psi (137.8 bar, 13.7 MPa)	
Weight	6.32 lb (2.87 kg)	
<b>Dimensions:</b>		
Length	13.25 in. (33.6 cm)	
Width	5.0 in. (12.7 cm)	
Height	10.375 in. (26.4 cm)	
Storage temperature range ◆❖	32° to 122°F (0° to 50°C)	
Operating temperature range ✓	40° to 90° F (4° to 32°C)	
Storage Humidity Range	0% to 95% relative humidity, non-condensing	
Sound Pressure Level	79.5 dBA† (for sound power level, add 11 dBa)	
Vibration Level Acceleration	Less than 8.2 feet/s <sup>2</sup> 2.5 m/s <sup>2</sup> ††	
<b>Charger:</b>		
Charging Time	45 - 75 minutes	
Power Source	120 VAC	240 VAC
<b>Battery:</b>		
Voltage	18 VDC, Lithium Ion	
Capacity	2.4 Ah, 43.2 Wh	

- ◆ Pump damage will occur if fluid freezes in pump.
- ❖ Damage to plastic parts may result if impact occurs in low temperature conditions.
- ✓ Changes in paint viscosity at very low or very high temperatures can affect sprayer performance.
- † per ISO 3744 measured at 3.1 feet (1m)
- †† per ISO 5349, no load condition

# Graco Standard Warranty

Graco warrants all equipment referenced in this document which is manufactured by Graco and bearing its name to be free from defects in material and workmanship on the date of sale to the original purchaser for use. With the exception of any special, extended, or limited warranty published by Graco, Graco will, for a period of twelve months from the date of sale, repair or replace any part of the equipment determined by Graco to be defective. This warranty applies only when the equipment is installed, operated and maintained in accordance with Graco's written recommendations.

This warranty does not cover, and Graco shall not be liable for general wear and tear, or any malfunction, damage or wear caused by faulty installation, misapplication, abrasion, corrosion, inadequate or improper maintenance, negligence, accident, tampering, or substitution of non-Graco component parts. Nor shall Graco be liable for malfunction, damage or wear caused by the incompatibility of Graco equipment with structures, accessories, equipment or materials not supplied by Graco, or the improper design, manufacture, installation, operation or maintenance of structures, accessories, equipment or materials not supplied by Graco.

This warranty is conditioned upon the prepaid return of the equipment claimed to be defective to an authorized Graco distributor for verification of the claimed defect. If the claimed defect is verified, Graco will repair or replace free of charge any defective parts. The equipment will be returned to the original purchaser transportation prepaid. If inspection of the equipment does not disclose any defect in material or workmanship, repairs will be made at a reasonable charge, which charges may include the costs of parts, labor, and transportation.

**THIS WARRANTY IS EXCLUSIVE, AND IS IN LIEU OF ANY OTHER WARRANTIES, EXPRESS OR IMPLIED, INCLUDING BUT NOT LIMITED TO WARRANTY OF MERCHANTABILITY OR WARRANTY OF FITNESS FOR A PARTICULAR PURPOSE.**

Graco's sole obligation and buyer's sole remedy for any breach of warranty shall be as set forth above. The buyer agrees that no other remedy (including, but not limited to, incidental or consequential damages for lost profits, lost sales, injury to person or property, or any other incidental or consequential loss) shall be available. Any action for breach of warranty must be brought within two (2) years of the date of sale.

**GRACO MAKES NO WARRANTY, AND DISCLAIMS ALL IMPLIED WARRANTIES OF MERCHANTABILITY AND FITNESS FOR A PARTICULAR PURPOSE, IN CONNECTION WITH ACCESSORIES, EQUIPMENT, MATERIALS OR COMPONENTS SOLD BUT NOT MANUFACTURED BY GRACO.** These items sold, but not manufactured by Graco (such as electric motors, switches, hose, etc.), are subject to the warranty, if any, of their manufacturer. Graco will provide purchaser with reasonable assistance in making any claim for breach of these warranties.

In no event will Graco be liable for indirect, incidental, special or consequential damages resulting from Graco supplying equipment hereunder, or the furnishing, performance, or use of any products or other goods sold hereto, whether due to a breach of contract, breach of warranty, the negligence of Graco, or otherwise.

## **FOR GRACO CANADA CUSTOMERS**

The Parties acknowledge that they have required that the present document, as well as all documents, notices and legal proceedings entered into, given or instituted pursuant hereto or relating directly or indirectly hereto, be drawn up in English. Les parties reconnaissent avoir convenu que la rédaction du présente document sera en Anglais, ainsi que tous documents, avis et procédures judiciaires exécutés, donnés ou intentés, à la suite de ou en rapport, directement ou indirectement, avec les procédures concernées.

# Graco Information

For the latest information about Graco products, visit [www.graco.com](http://www.graco.com).

**TO PLACE AN ORDER**, contact your Graco distributor or call to identify the nearest distributor.

**Phone:** 612-623-6926 **or Toll Free:** 1-800-690-2894 **Fax:** 612-623-6893 **Toll Free Fax:** 1-800-334-6955

*All written and visual data contained in this document reflects the latest product information available at the time of publication.  
Graco reserves the right to make changes at any time without notice.*

Original instructions. **This manual contains English. MM 3A0153**

**Graco Headquarters:** Minneapolis

**International Offices:** Belgium, China, Japan, Korea

**GRACO INC. AND SUBSIDIARIES • P.O. BOX 1441 • MINNEAPOLIS MN 55440-1441 • USA**

**Copyright 2011, Graco Inc. All Graco manufacturing locations are registered to ISO 9001.**

[www.graco.com](http://www.graco.com)  
Revised 11/2011